

The production, transmission or use of this document or its contents is not permitted without express written authority. Offenders will be liable for damages. All right including rights created by patent or registration of a utility model or design are reserved.

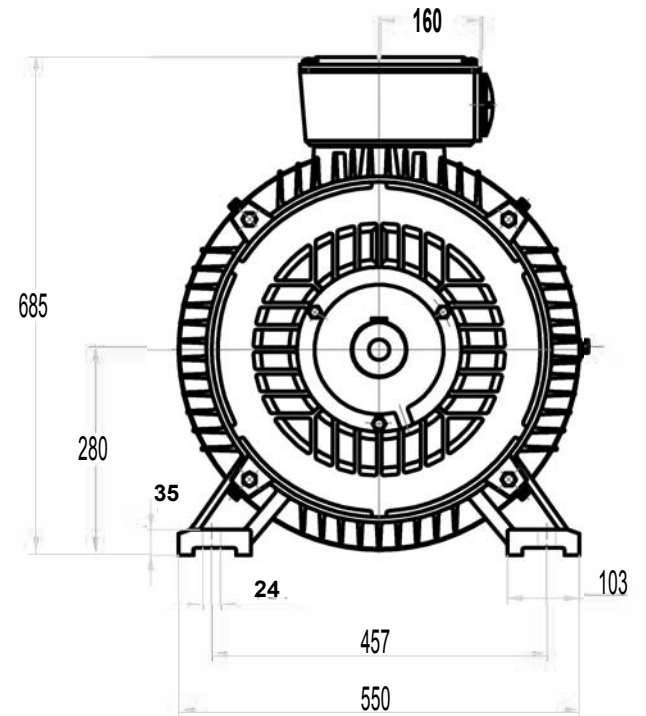
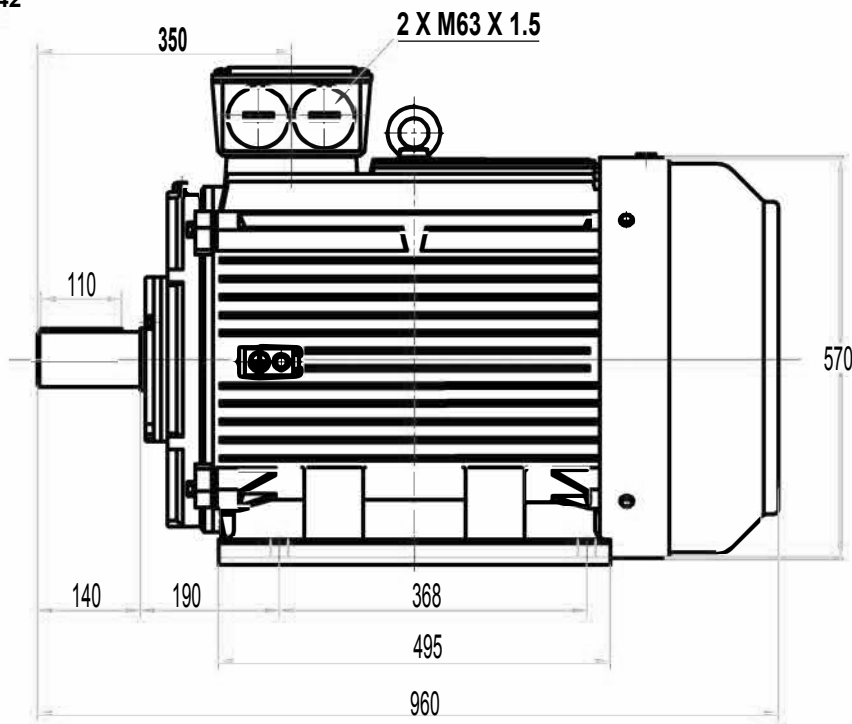
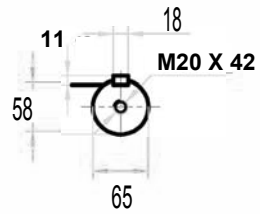

备(图)件登记

插图

描 绘

日期图总号

图总号

签 字

日 期

CUSTOMER APPROVAL

SIGNATURE

DATE

BR1-280S-2 (B3)
DIMENSION OUTLINE

BRANCO

DATE	2013.1	CHK
DRAWN	zhang	APPD
ISSUE A	DATE	CERTIFIED BY
ISSUE B	DATE	CERTIFIED BY
ISSUE C	DATE	CERTIFIED BY
ISSUE D	DATE	CERTIFIED BY